

THIS DRAWING MAY BE PREPARED IN COLOUR AND MAY BE INCOMPLETE IF COPIED  
50mm ON A3 SIZE ORIGINAL

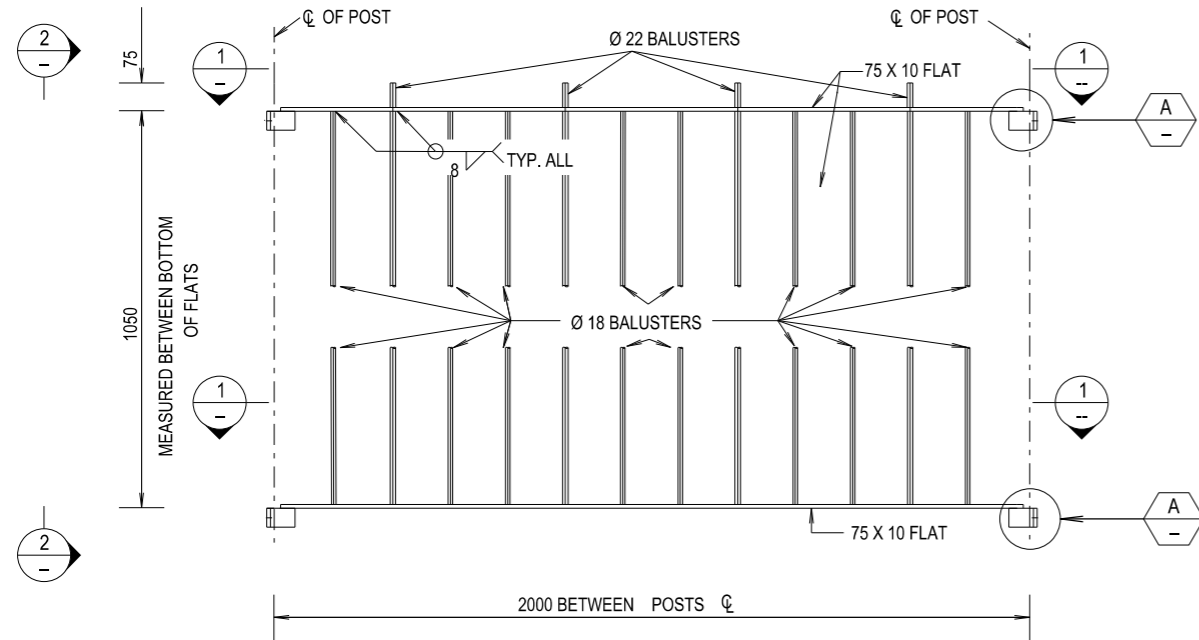

ELEVATION

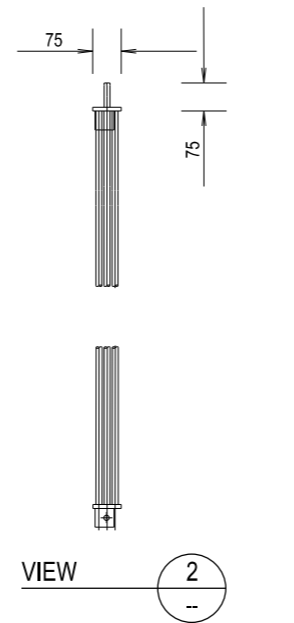

VIEW 2

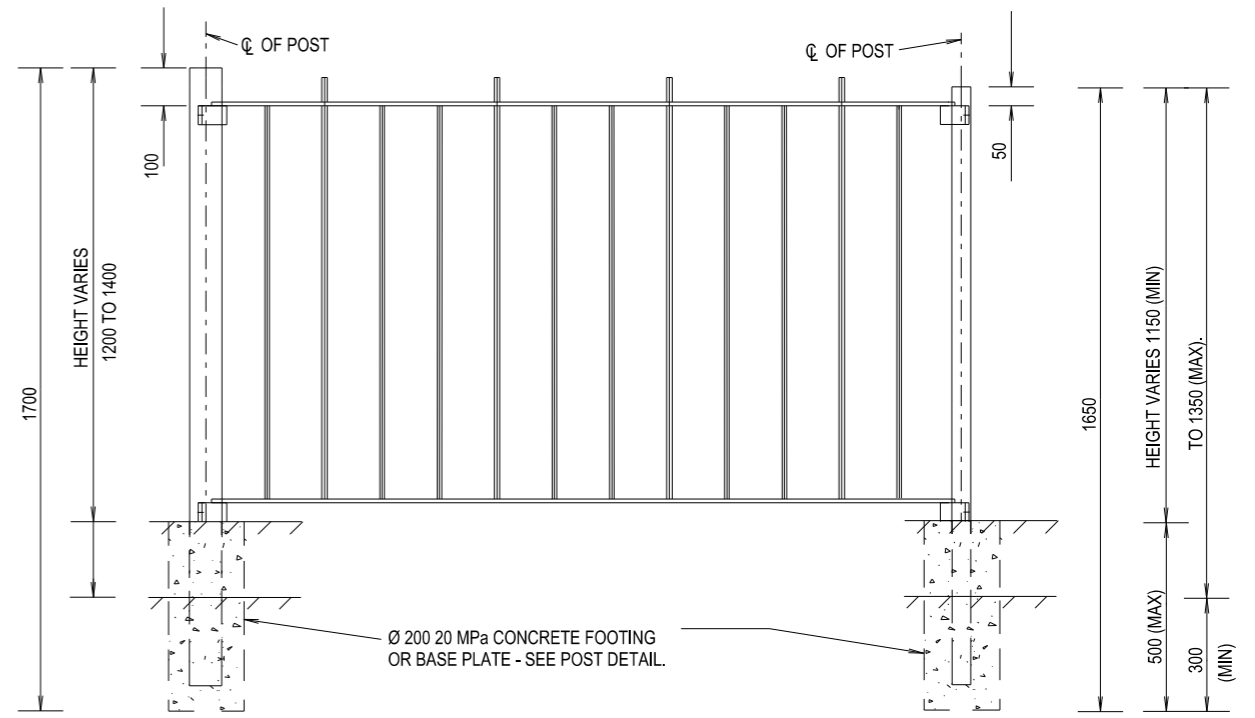
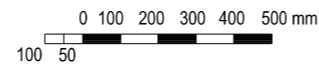

END POST

INTERMEDIATE POST

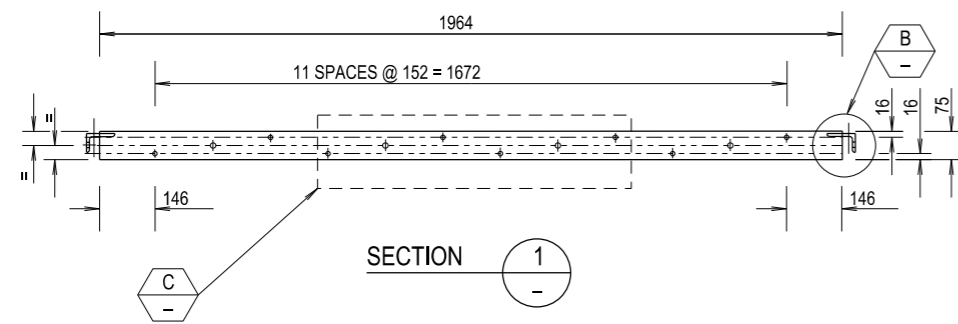

SECTION 1

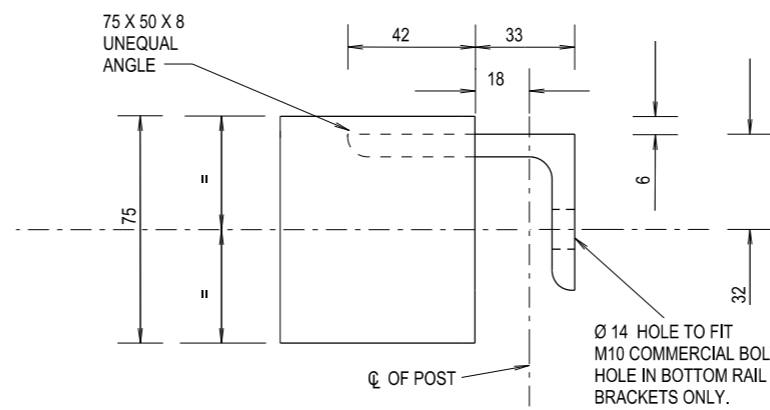
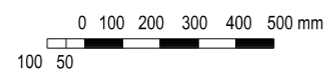

DETAIL B

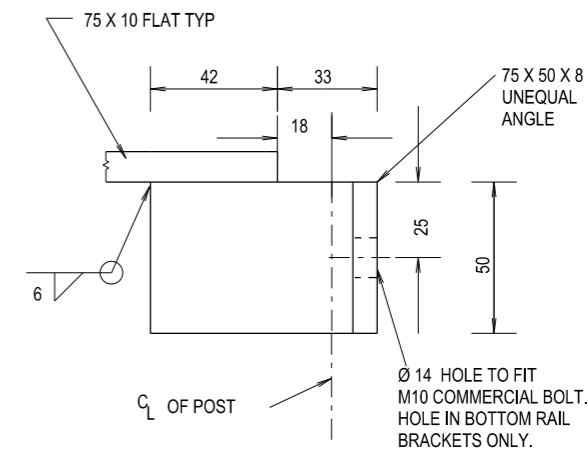
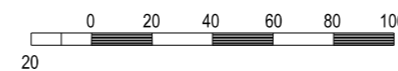

DETAIL A

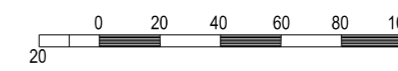

ANGLE BRACKETS

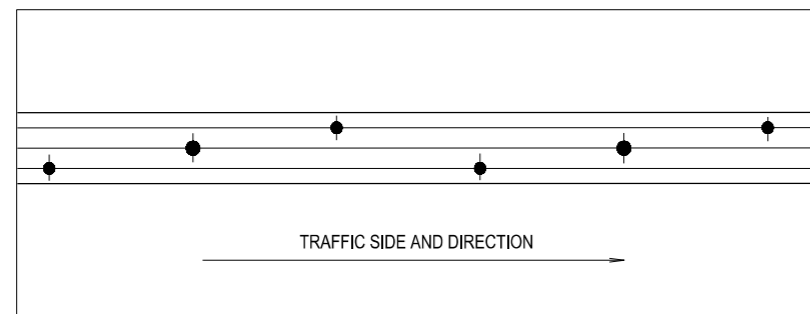

DETAIL C

ALL DIMENSIONS ARE IN MILLIMETRES UNLESS OTHERWISE SHOWN

QR CODE	SCAN TO CHECK DOCUMENT VER.	REV	DATE	AMENDMENT / REVISION DESCRIPTION	WVR No.	APPROVAL	SCALES ON A3 SIZE DRAWING	CONTACT DETAILS	ISSUED	STANDARD DRAWING No.	REV.
								SEND FEEDBACK ON THIS STANDARD DRAWING TO : technologystandards@rms.nsw.gov.au	SFR	R0800-17	-
								MANAGER ROAD POLICY, SPECIFICATIONS & TECHNOLOGY	PREPARED BY ENGINEERING SERVICES ROAD POLICY, SPECIFICATIONS AND AND TECHNOLOGY	EDMS No. DS2014/006004	ORIGINAL ISSUE DATE JANUARY 2017



STANDARD DRAWING  
ROAD DESIGN ENGINEERING  
R0800 FENCING SERIES  
PEDESTRIAN FENCE  
TYPE 2 - VERGE

A3

SHEET 1 OF 1

DATE 20.01.17